

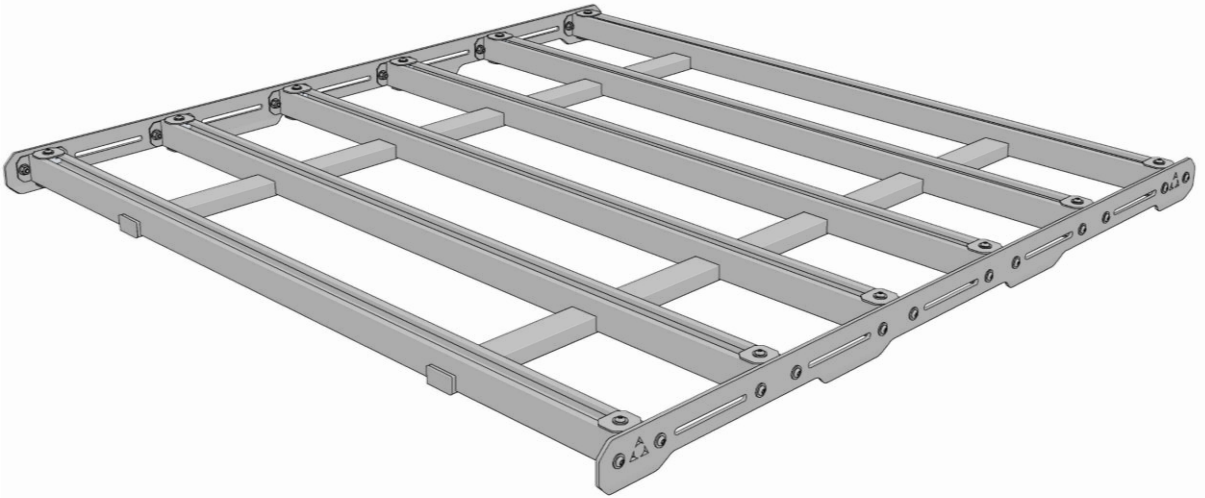



ApexOEM

3211411-48" L X 48" W PLATFORM RACK



 INSTALL TIME: 90 MIN.

TOOLS REQUIRED

A	RATCHET
B	7/16" SOCKET
C	5/32" ALLEN KEY

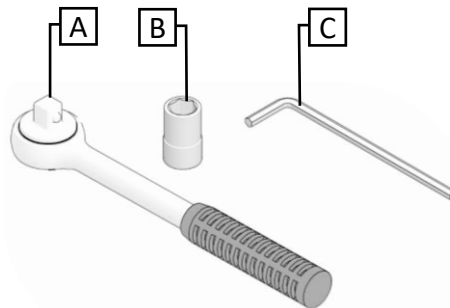

PARTS LIST

ITEM	QTY.	DESCRIPTION	PART NO.
1	4	1-5/8" CHANNEL END CAP	X20173120
2	4	TOP MOUNT PLATE	A000-115-B
3	12	CONNECTING BRACKET	3211411-1002
4	4	TOP MOUNT BRACKET	3211411-1003
5	4	BOTTOM MOUNT BRACKET	3211411-1004
6	2	SIDE RAIL	3211411-1000
7	6	CROSS CHANNEL	3211411-2011
8	2	SUPPORT CHANNEL	3211411-2018
9	8	1/4"-20 X 1" BUTTON HEAD SCREW	
10	8	1/4" FLAT WASHER	
11	32	1/4"-20 STRUT NUT	191425-01
12	8	1/4"-20 CHANNEL STUD	191925-01
13	8	TREADED KNOB	321126-100
14	1	HADWARE KIT	3211411-100
14.1	60	1/4"-20 X 3/4" BUTTON HEAD SCREW	
14.2	36	1/4"-20 LOCK NUT	
14.3	96	1/4" FLAT WASHER	

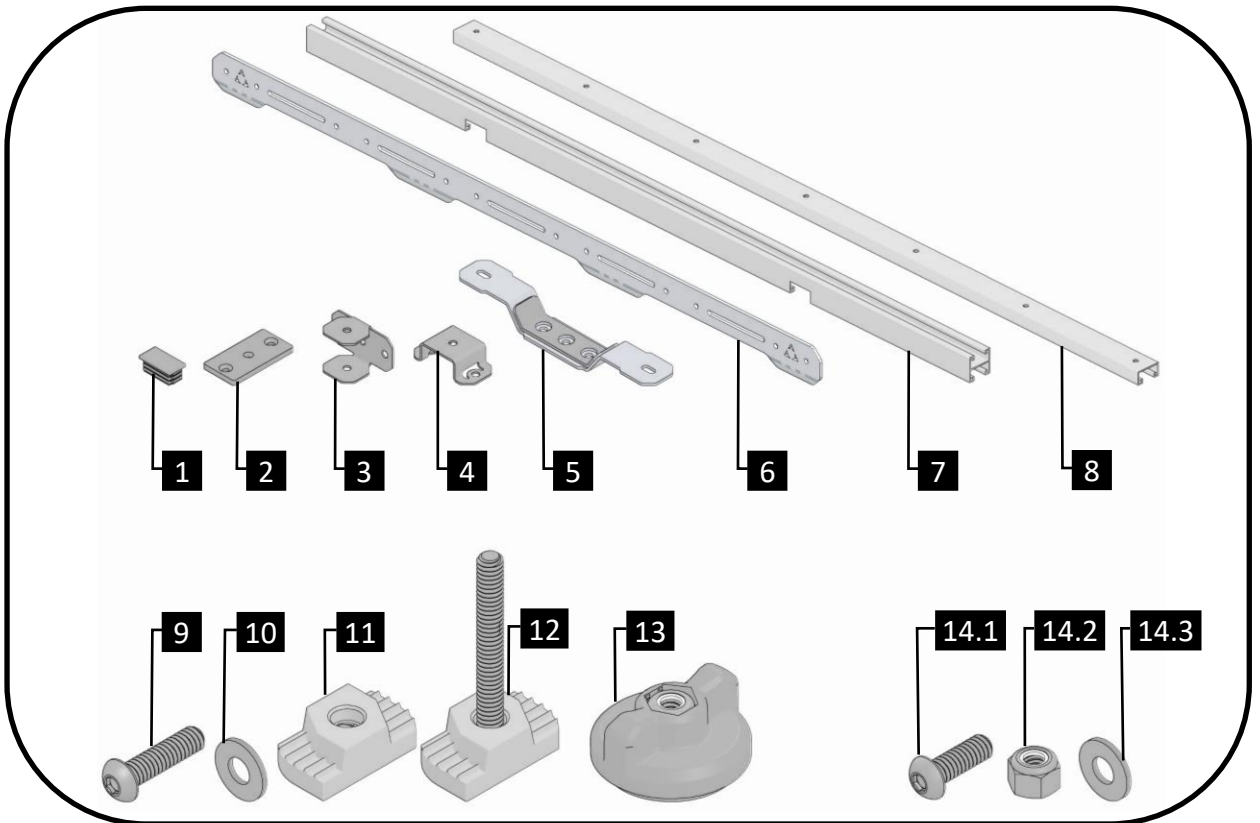

1

ASSEMBLE FRAME AS SHOWN

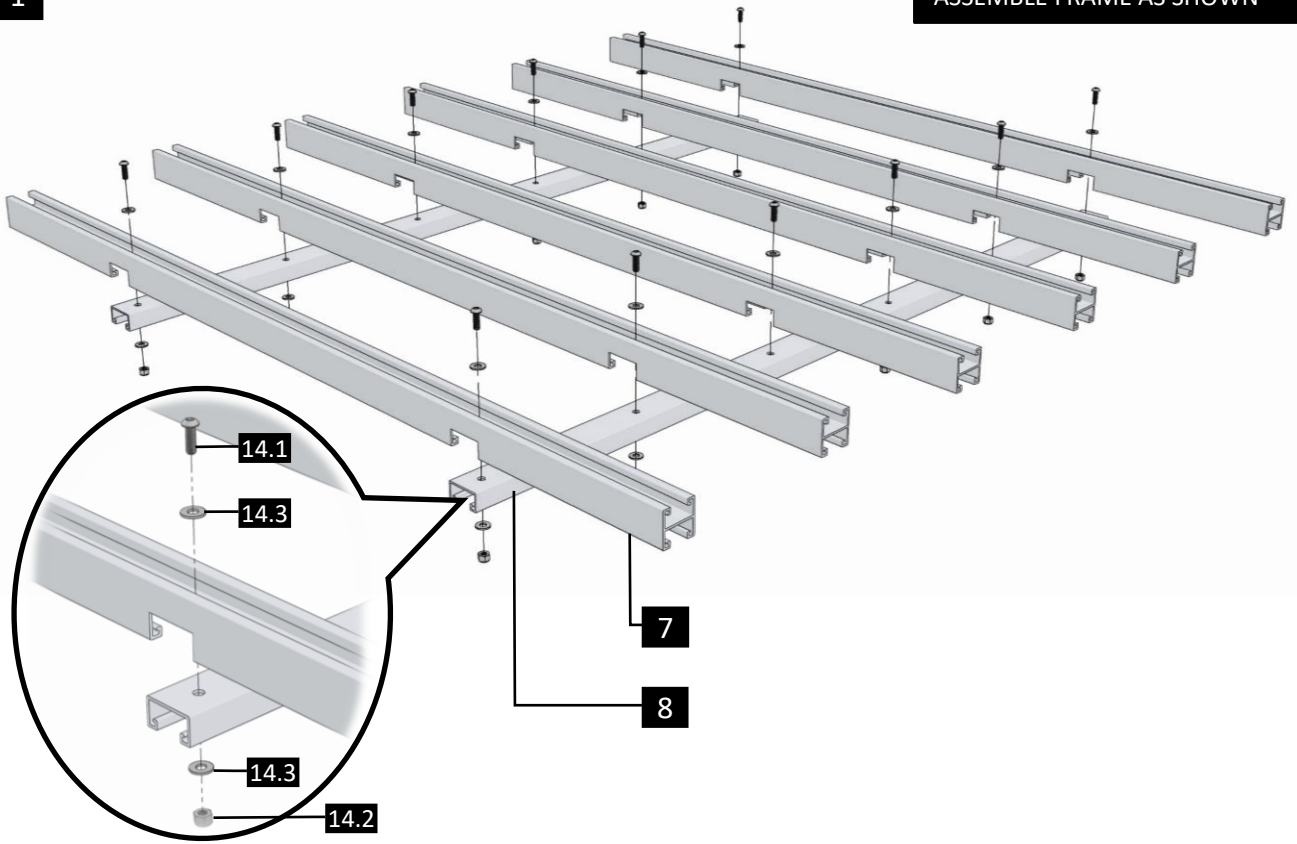

2

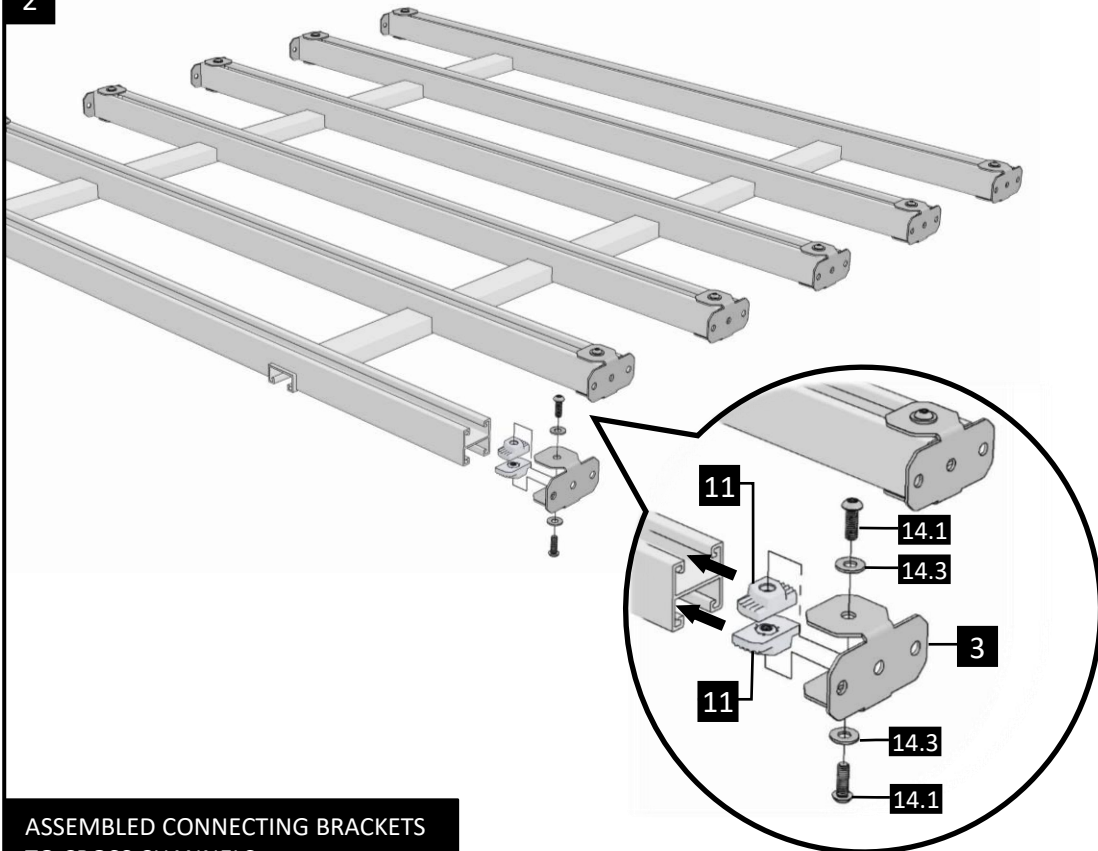

ASSEMBLED CONNECTING BRACKETS TO CROSS CHANNELS.

3

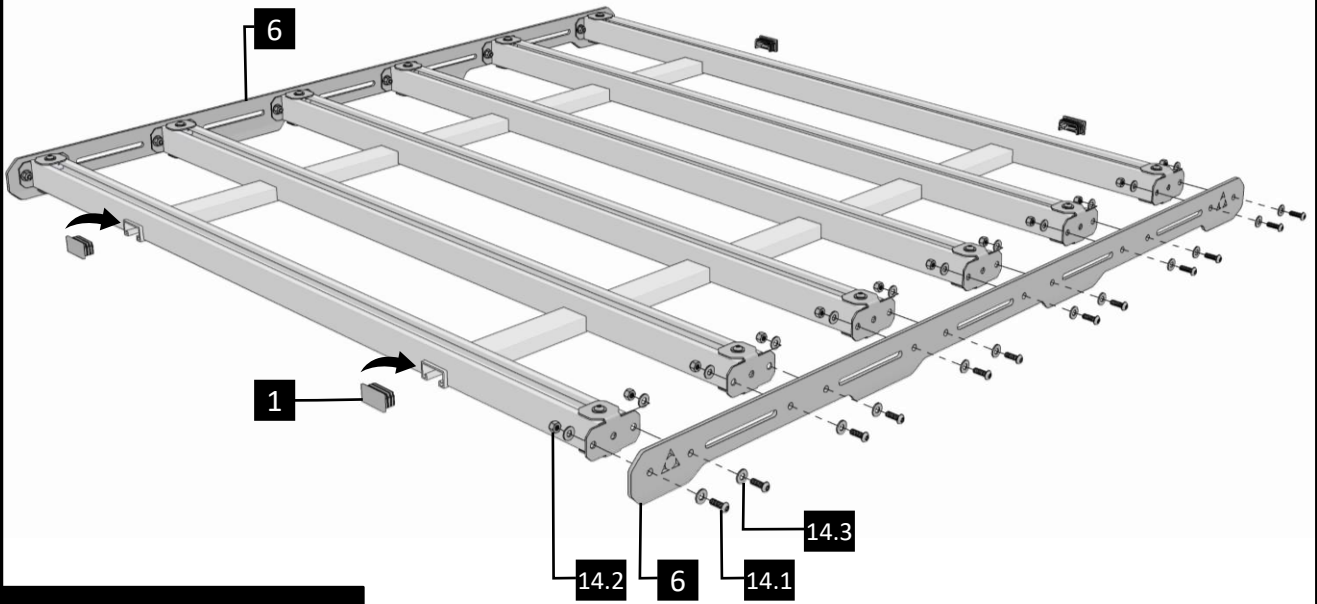

ASSEMBLED SIDE RAILS TO CONNECTING BRACKETS.

4

MOUNTING OPTION 1

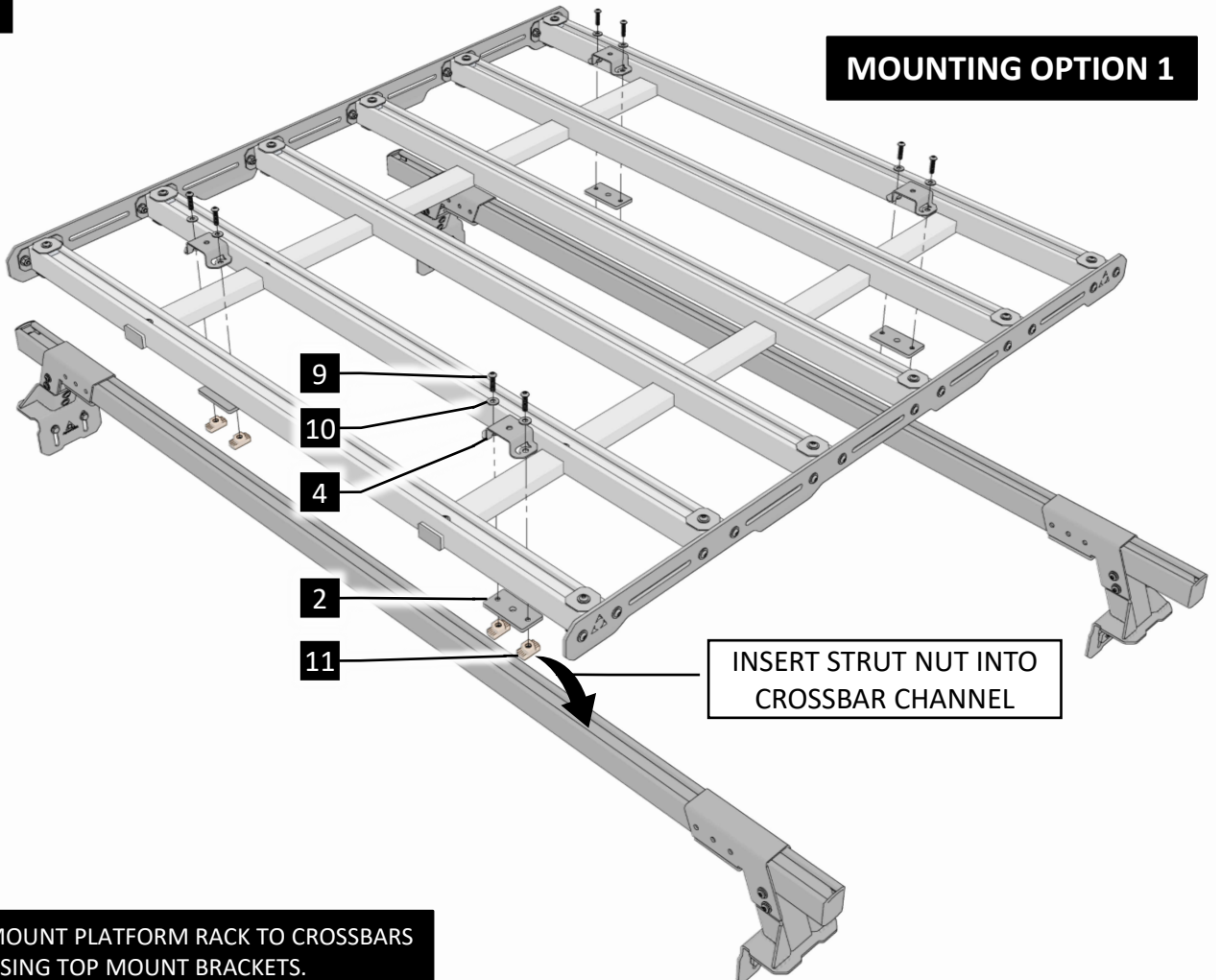

MOUNT PLATFORM RACK TO CROSSBARS USING TOP MOUNT BRACKETS.

5

MOUNTING OPTION 1

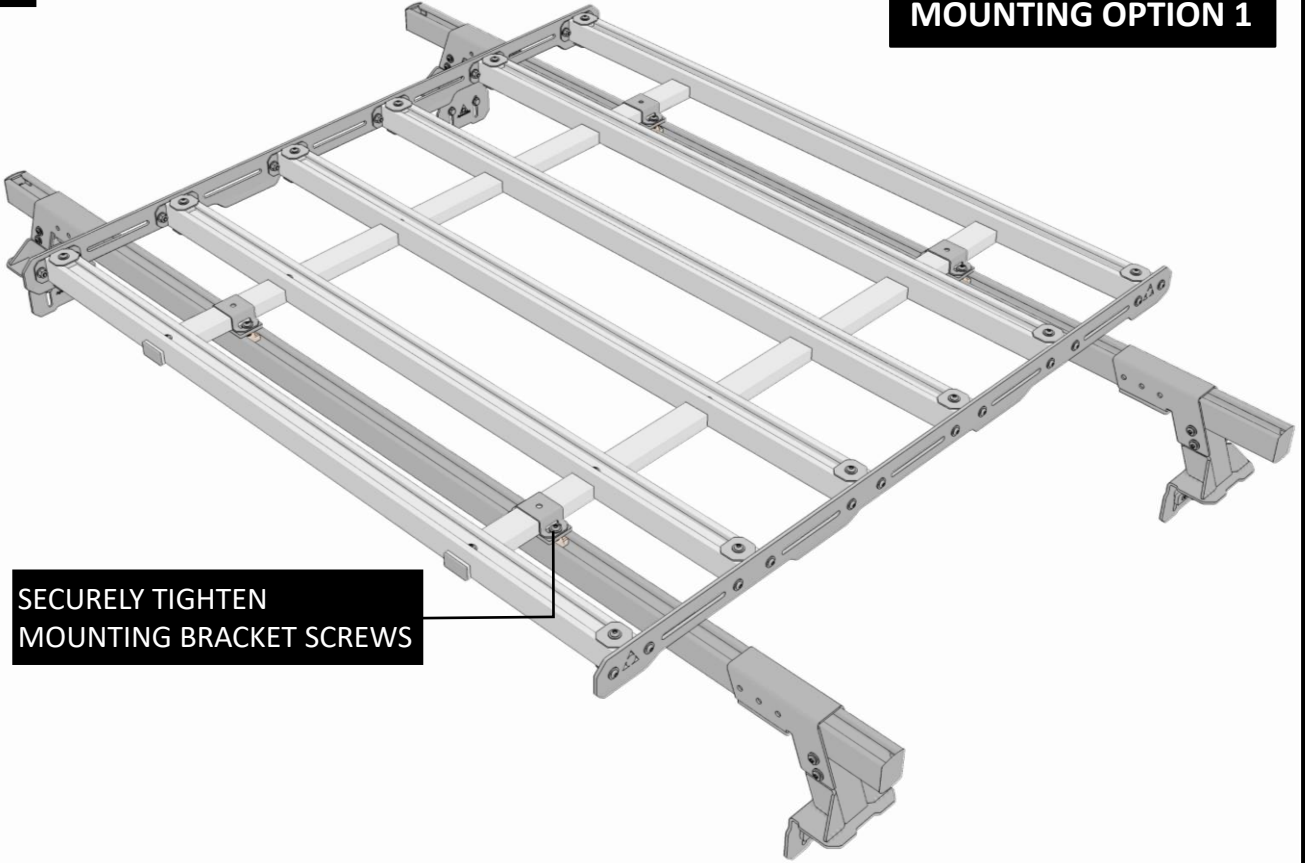

**SECURELY TIGHTEN
MOUNTING BRACKET SCREWS**

6

MOUNTING OPTION 2

**INSERT CHANNEL STUD INTO
SUPPORT CHANNEL AND
TURN 90 DEG.**

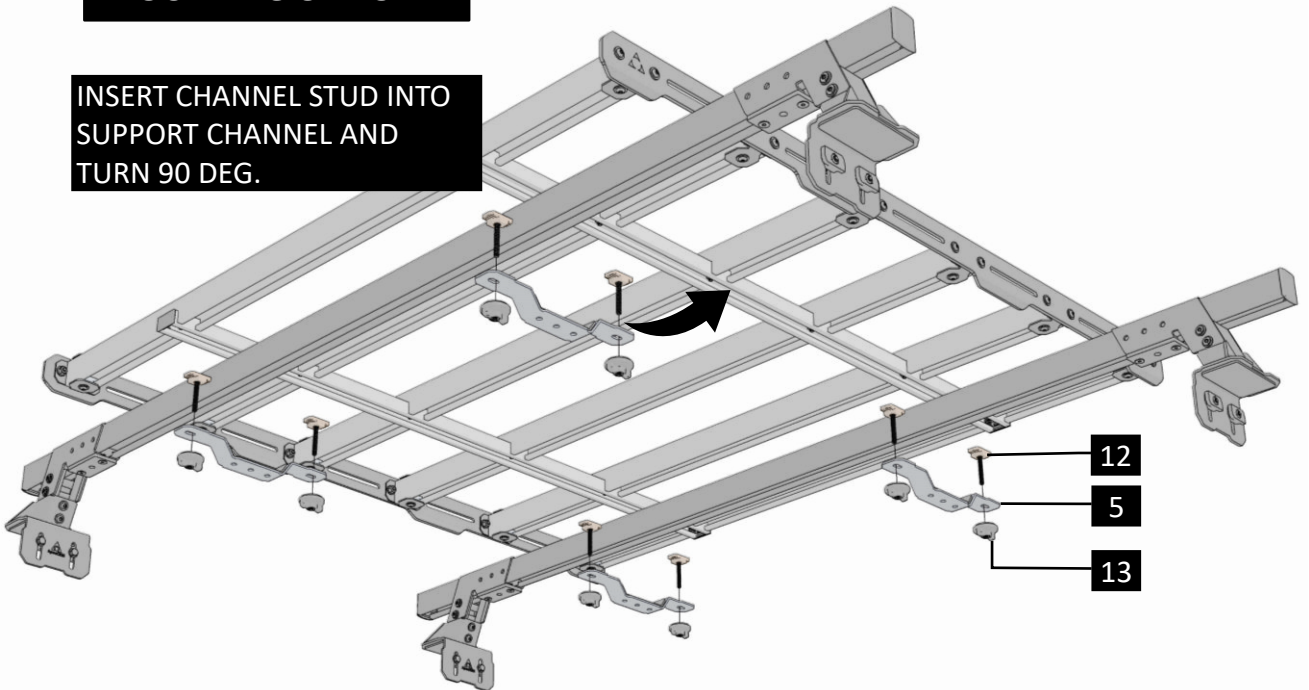

- 12
- 5
- 13

**MOUNT PLATFORM RACK TO CROSSBARS
USING BOTTOM MOUNT BRACKETS.**



**SECURELY TIGHTEN
MOUNTING BRACKET KNOBS**

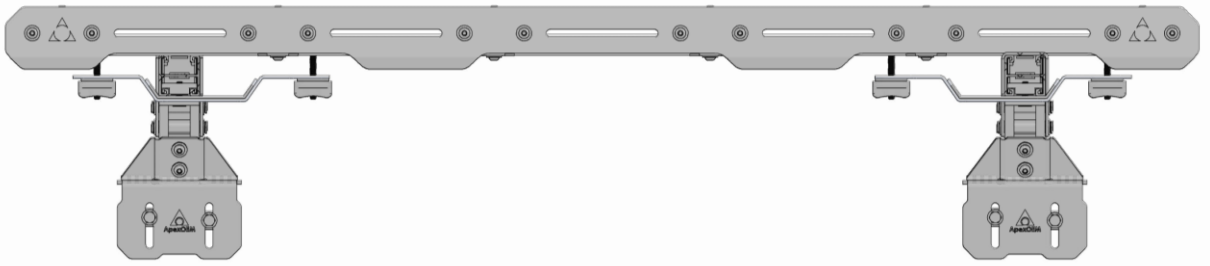

CHECK THAT RACK IS SECURELY MOUNTED