



ApexOEM

3211421 BASKET KIT



 INSTALL TIME: 45 MIN.

TOOLS REQUIRED

A	RATCHET
B	7/16" SOCKET
C	5/32" ALLEN KEY

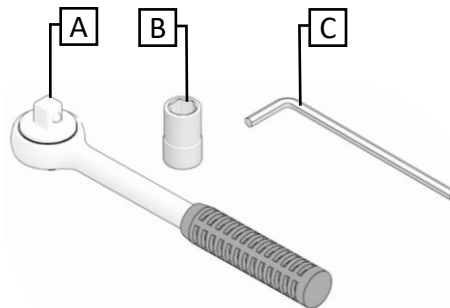



ApexOEM

3211421 BASKET KIT

PARTS LIST

ITEM	QTY.	DESCRIPTION	PART NO.
1	14	¼"-20 STRUT NUT	191425-01
2	2	CONNECTING BRACKET	3211411-1002
3	1	CHANNEL COVER	3211421-1002
4	1	CROSS CHANNEL	3211421-1001
5	1	SIDE RAIL, RIGHT HAND	3211421-1000RH
6	1	SIDE RAIL, LEFT HAND	3211421-1000LH
7	1	HADWARE KIT	3211421-100
7.1	8	¼"-20 X ¾" BUTTON HEAD SCREW	
7.2	4	¼"-20 LOCK NUT	
7.3	22	¼" FLAT WASHER	
7.4	10	¼"-20 HEX HEAD SCREW	

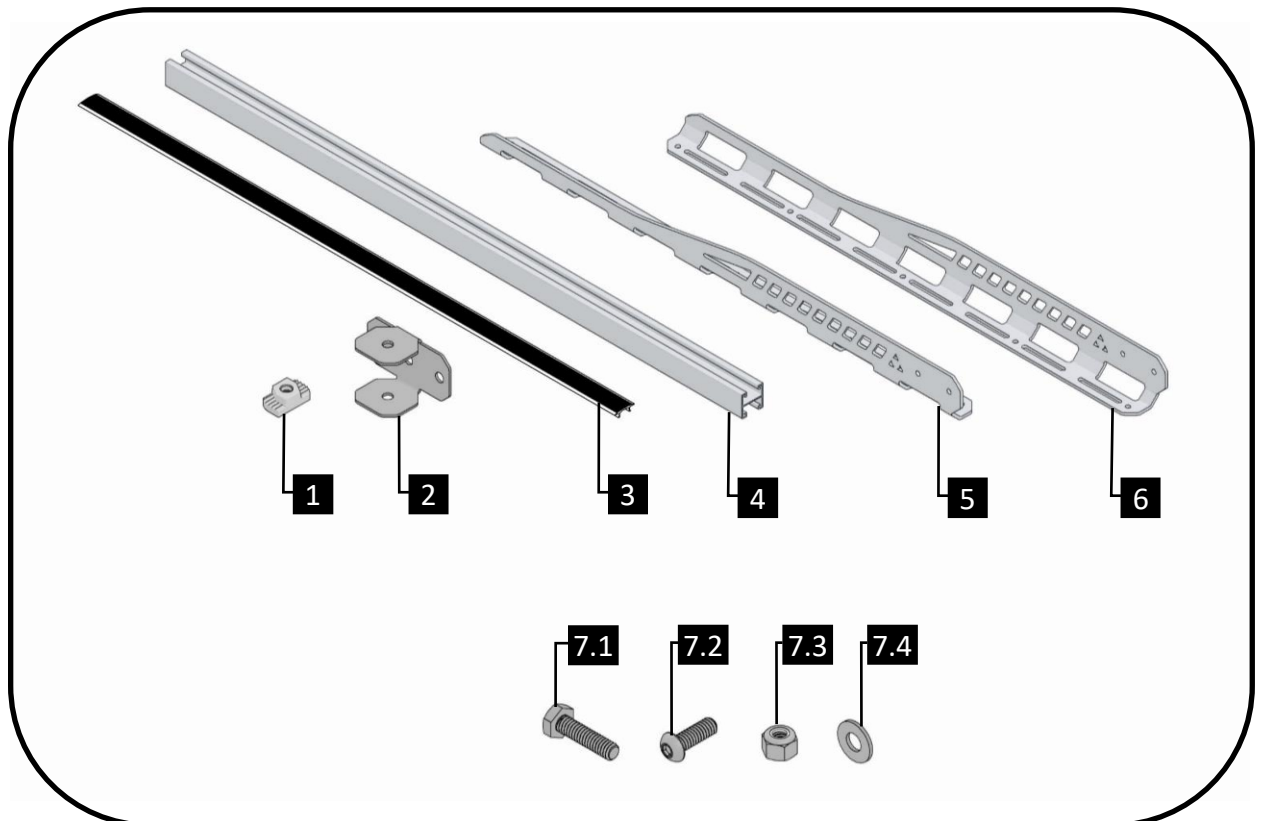

1

ASSEMBLE CONNECTING BRACKETS TO CROSS CHANNEL.

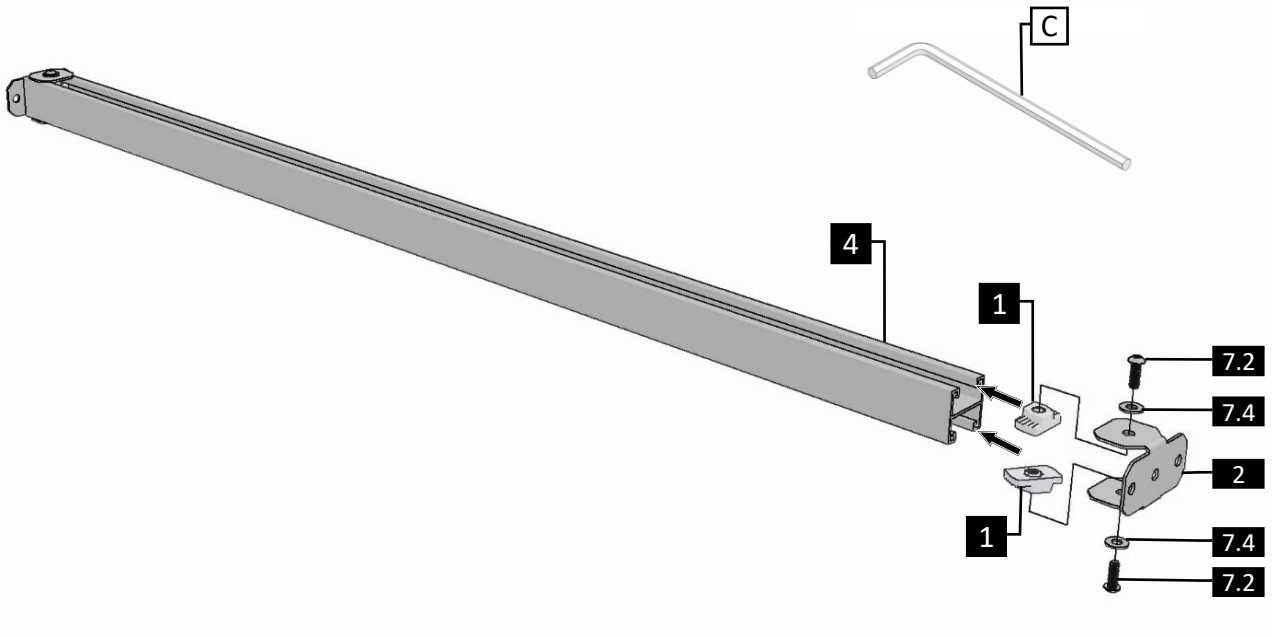

2

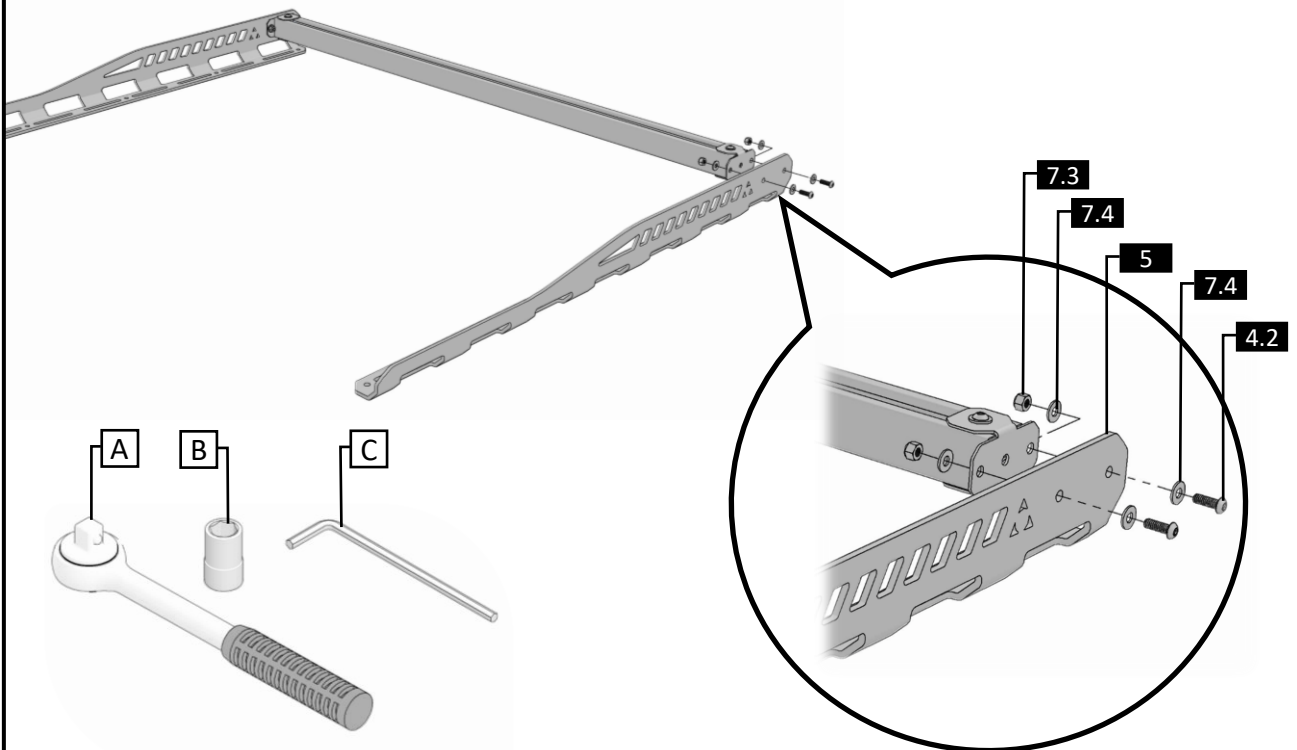

ASSEMBLED SIDE RAILS TO CONNECTING BRACKETS.

3

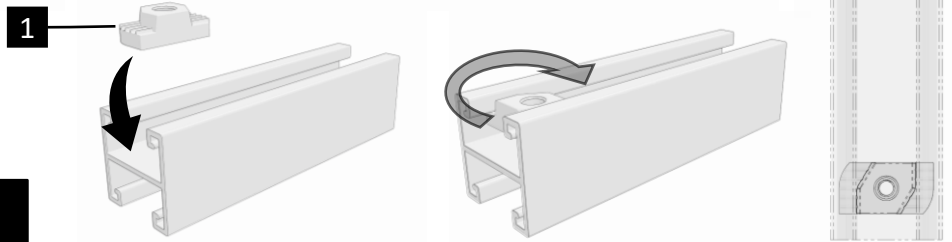
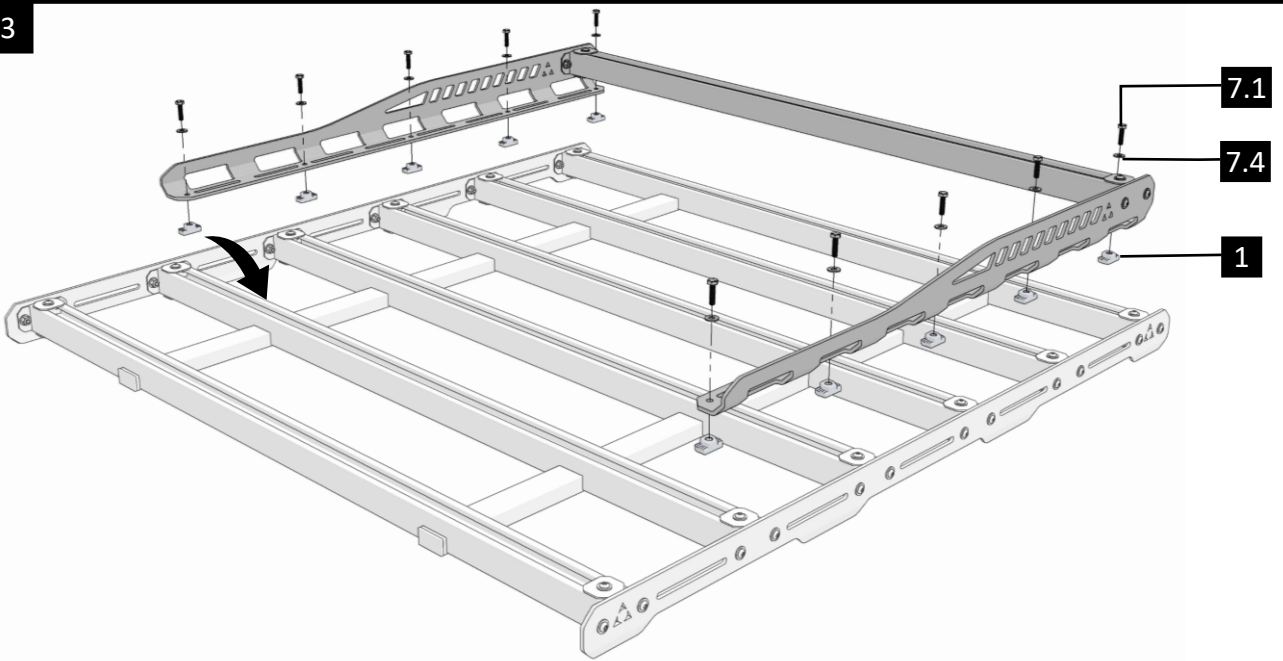

ALIGN BASKET WITH RACK AND INSERT CHANNEL NUTS.

4



SECURELY TIGHTEN ALL 1/4"-20 HEX HEAD SCREWS.

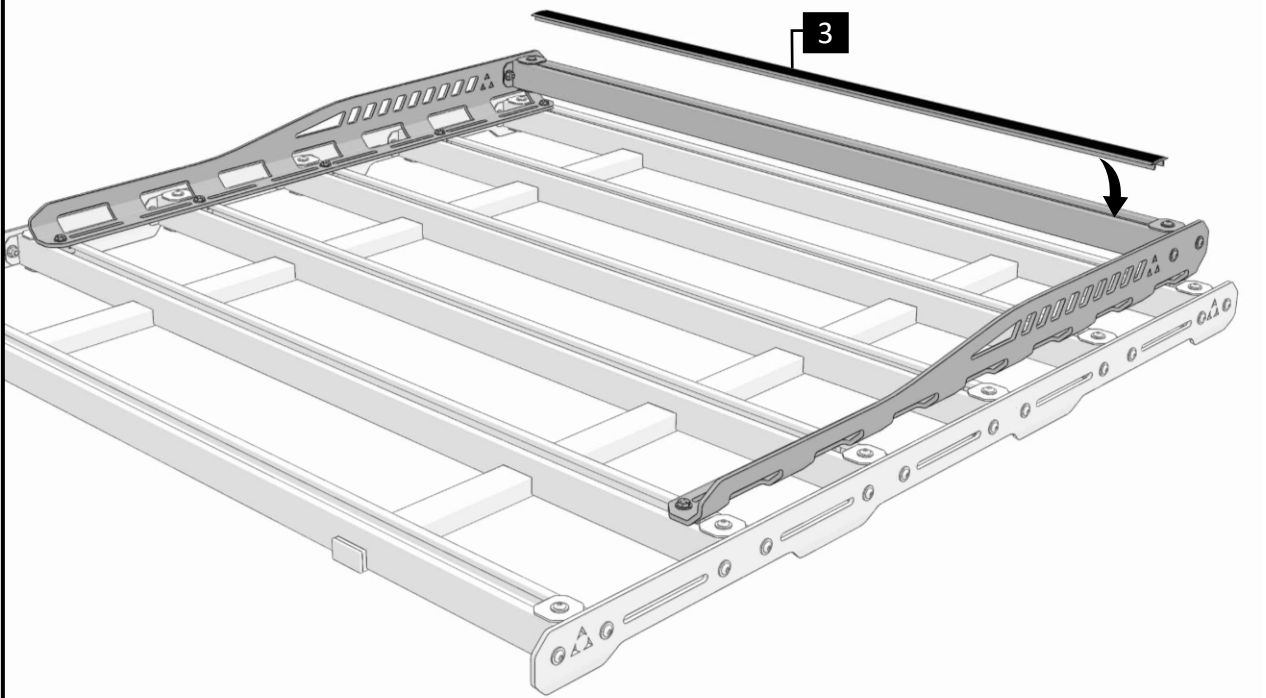

CHECK THAT ALL FASTENERS ARE SECURED.