

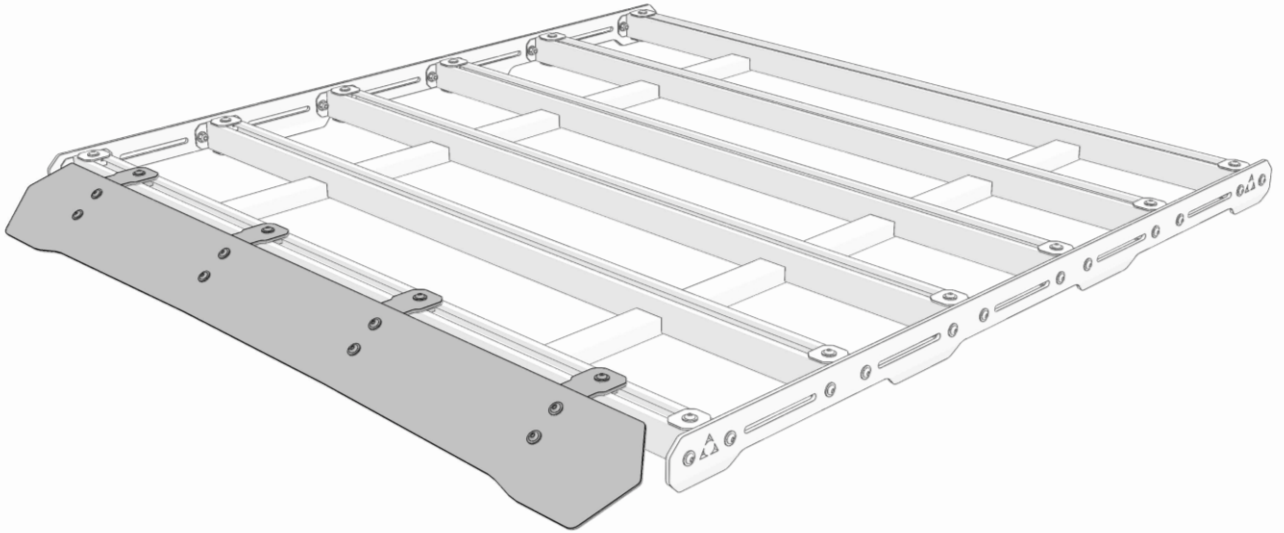

ApexOEM

3211581 WIND FAIRING 48



INSTALL TIME: 30 MIN.

TOOLS REQUIRED

A	RATCHET
B	7/16" SOCKET
C	5/32" ALLEN KEY

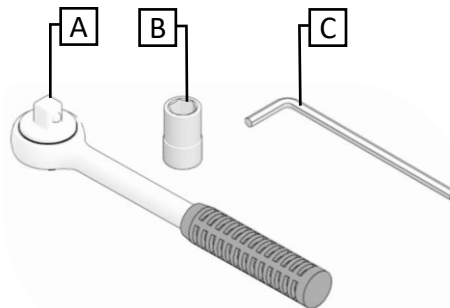



ApexOEM

3211581 WIND FAIRING 48

PARTS LIST

ITEM	QTY.	DESCRIPTION	PART NO.
1	1	FAIRING	3211581-1000
2	2	FAIRING BRACKET	3211581-1002
3	4	¼"-20 STRUT NUT	191425-01
4	1	HADWARE KIT	3211581-100
4.1	12	¼"-20 BUTTON HEAD SCREW	
4.2	8	¼"-20 LOCK NUT	
4.3	20	¼" FLAT WASHER	

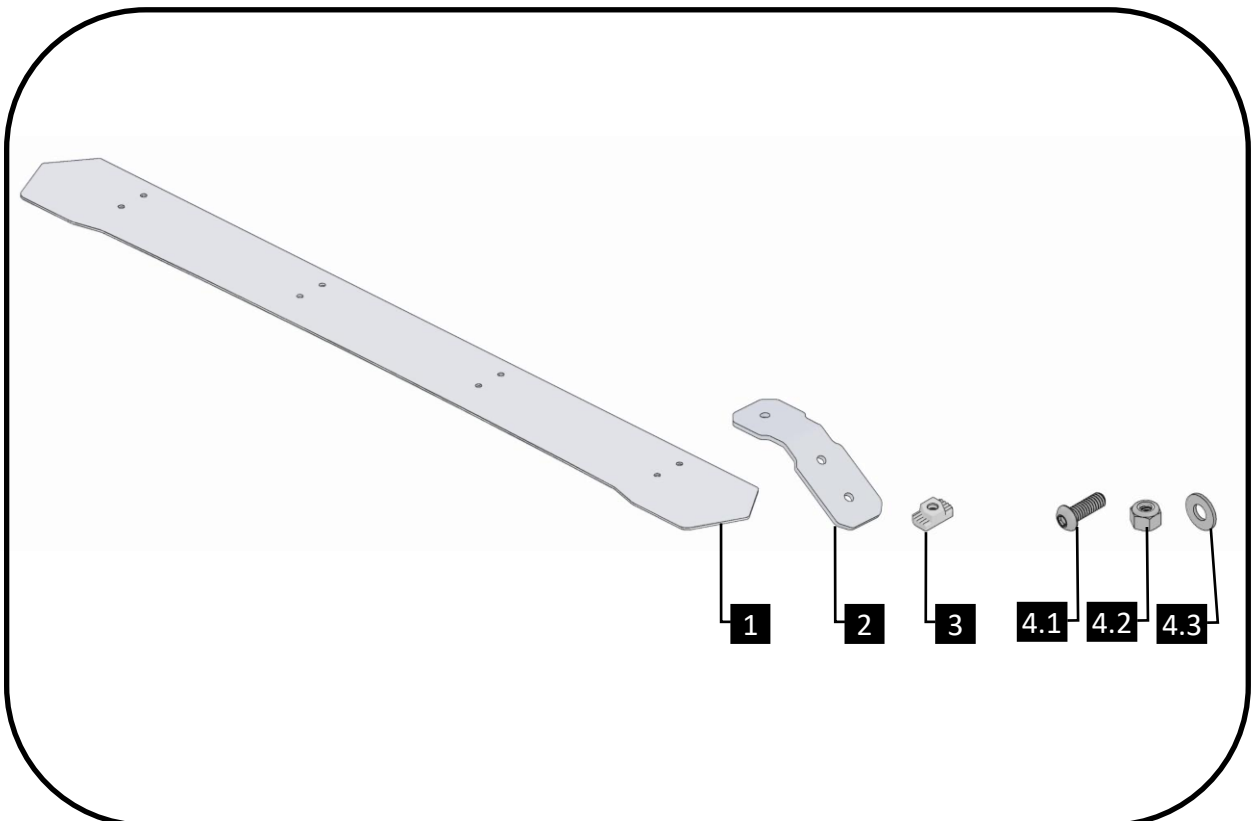

1

ASSEMBLE FAIRING BRACKETS TO FAIRING.

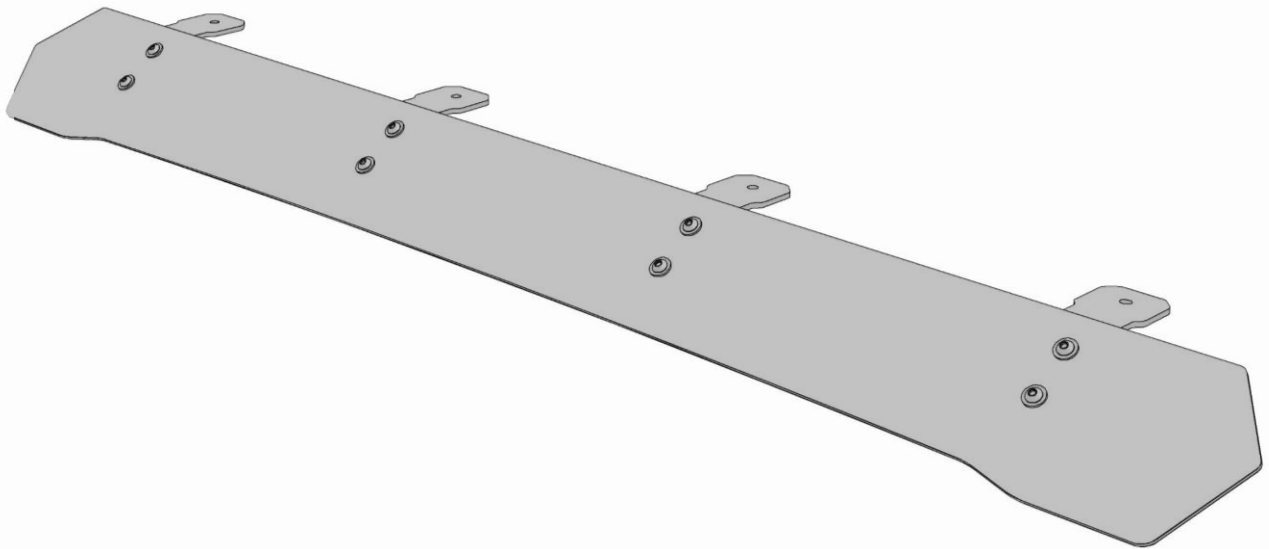
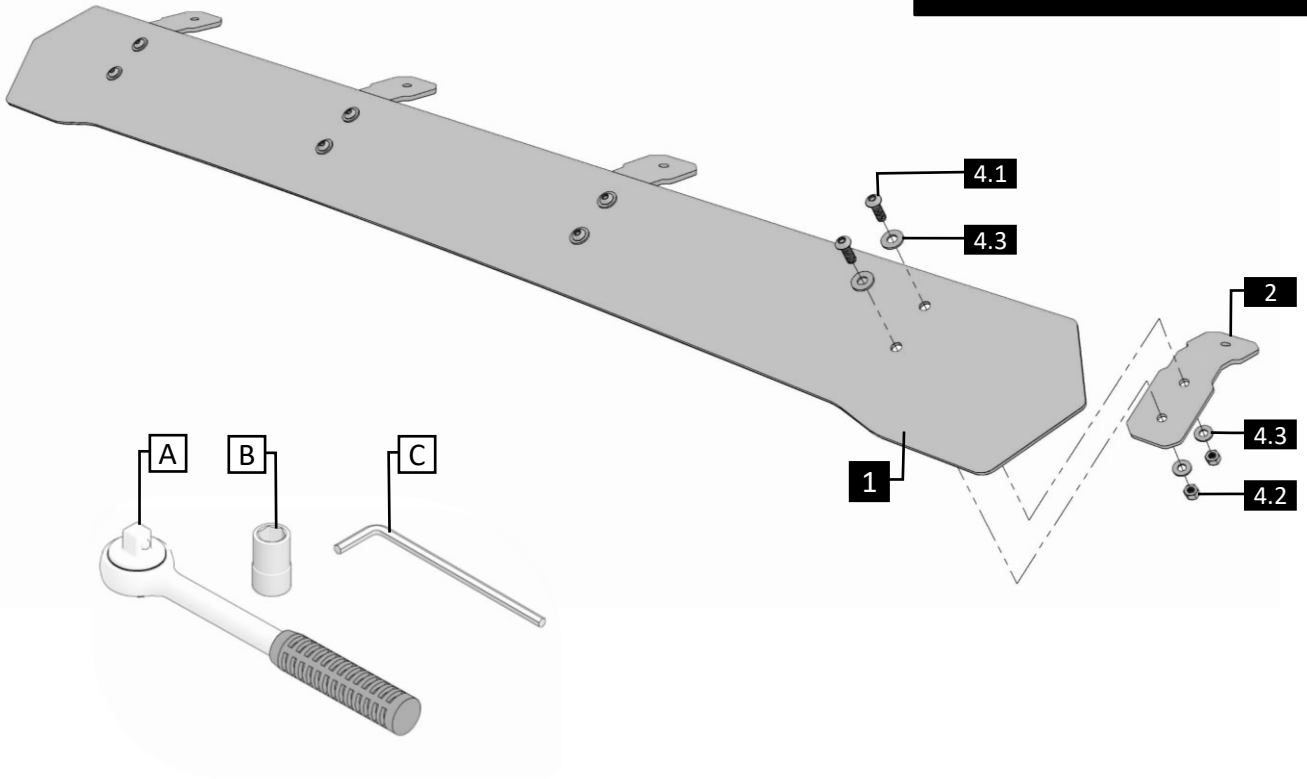

2

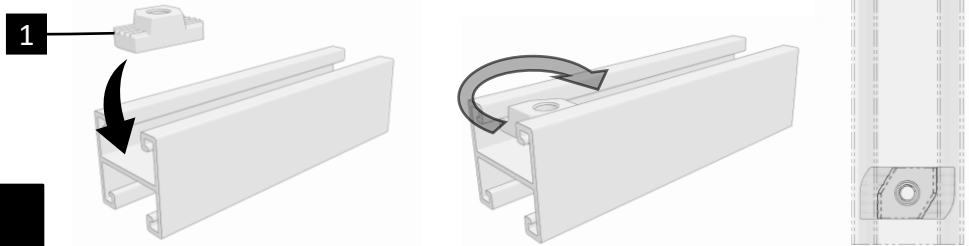
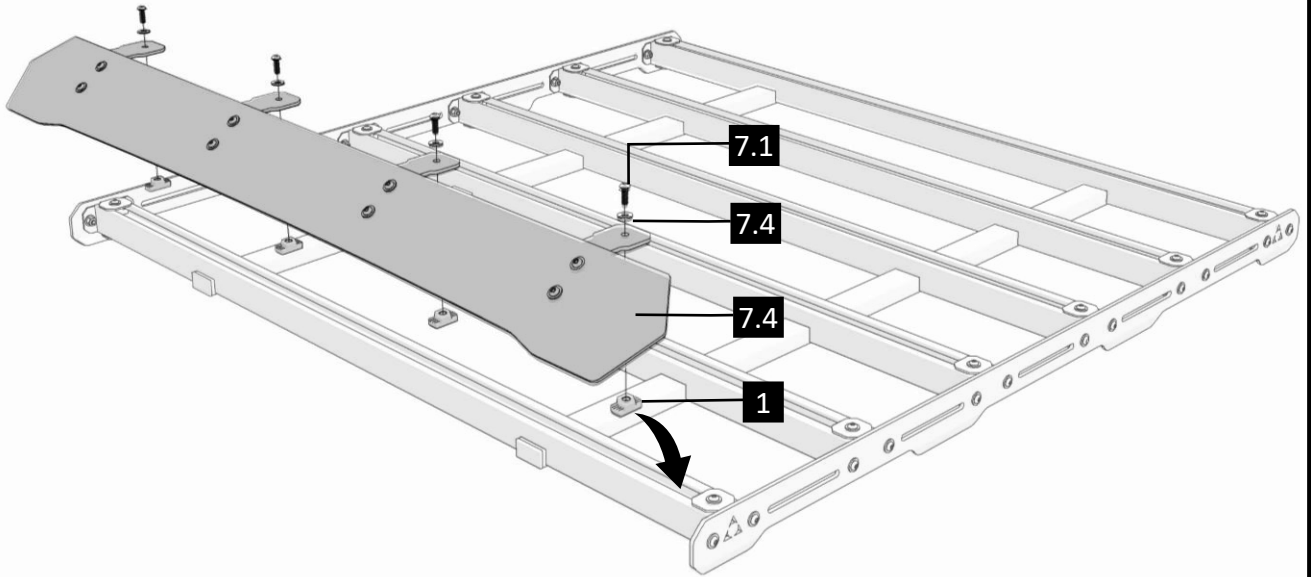

INSERT STRUT NUTS AND
ALIGN FAIRING WITH RACK.

3

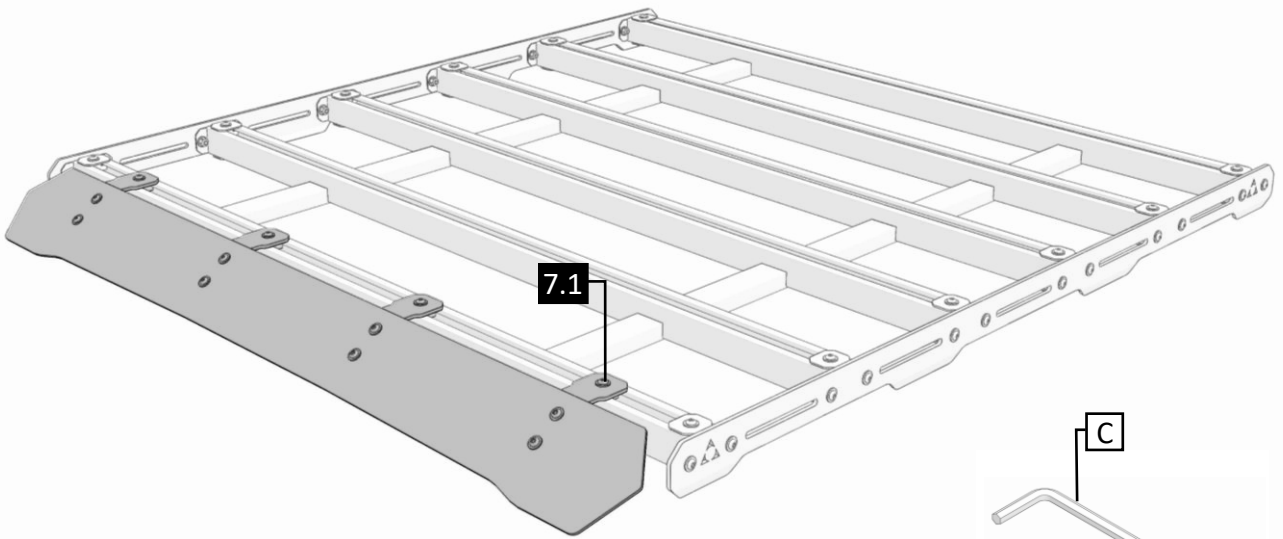

SECURELY TIGHTEN ALL 1/4"-20
BUTTON HEAD SCREWS.